

## 防水Micro USB母座卧式贴片6Pin防水IPX7数据接口1.8A~1A厂家LZG

产品名称	防水Micro USB母座卧式贴片6Pin防水IPX7数据接口1.8A~1A
生产厂家	广东小迈实业有限公司
价格	/
规格参数	品牌:LZG Micro:1.8A贴片6Pin 特性:防水IPX7
公司地址	东莞市横沥镇西城一区西聚路1号
联系电话	18938295875

### 产品详情

#### 防水Micro USB母座卧式贴片6Pin防水IPX7数据接口1.8A~1A厂家LZG

规格：ZB43006-06SBAP-A，包装MPQ:1000PCS/盘

端口数量：1安装类型：卧式贴板额定电流：1AIP等级：IP67



ZB43006-06SBAP-A

**IPX7**  
**IP67**  
**1.8~1A**



**防水Micro usb**

致力提供防水连接器解决方案

**防水**





防水Micro

源头工厂

支持定制

免费拿样



防水

ZB43006-06SBAP-A

生产厂家 欢迎来访

# 产品应用



汽车领域  
Automotive Electronics Field



数码产品  
Digital Product



电子产品  
Electronics



家用电器  
Household Appliances

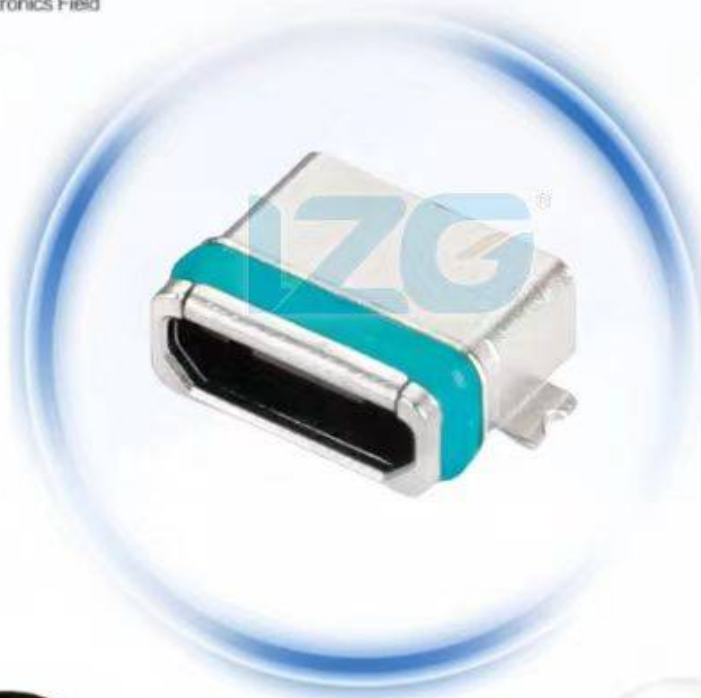

影音产品  
Audio and video products



通信产品  
Communication Products



智能家居  
Smart Home



## 专注防水连接器生产制造



## ✓ NOTES:

---

1. Current rating: 1,5PIN 1.8A Max/2,3,4PIN 1A Max.
2. Dielectric withstanding voltage: 100 V(ac) for 1 min.
3. Contact resistance: 30 mΩ Max.
4. Insulation resistance: 100 MΩ Min.
5. Total mating force: 3.57 Kgf Max.
6. Total unmating force: 1.0 Kgf Min.
7. Temperature range: -30°C~80°C.
8. Waterproof: IPX7.

ISO  
9001:2015

✓  
RoHS

✓ ISO  
14001:2015



**LZG INDUSTRIAL CO.,LTD**

RoHS  
Compl.Limit



ZONE	ECN.NO.	DESCRIPTION	DRAWING	DATE
A		INITIAL	林生爵	2020.02.18

SPECIFICATIONS:

- 1 Current rating:1,5PIN 1.8A Max/2,3,4PIN 1A Max.
- 2 Dielectric withstanding voltage:100 V(ac) for 1 min.
- 3 Contact resistance: 30 mΩ Max.
- 4 Insulation resistance: 100 MΩ Min.
- 5 Total mating force: 3.57 Kg Max.
- 6 Total unmating force: 1.0 Kg Min.
- 7 Temperature range: -30°C~80°C
- 8 Waterproof: IPX7.

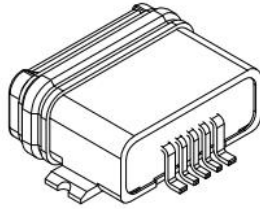
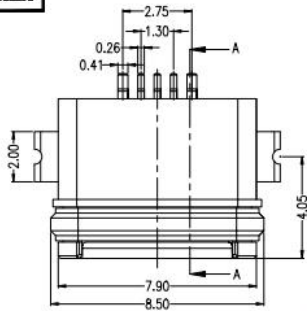

3D VIEW

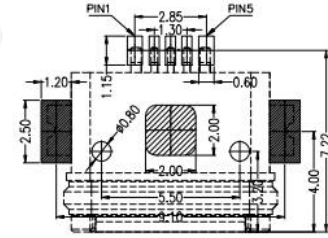
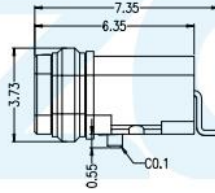
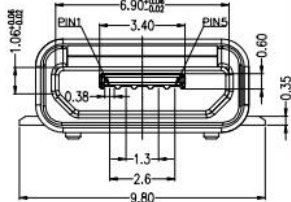

RECOMMENDED P.C.B. LAYOUT  
TOLERANCE UNSPECIFIED ±0.05mm

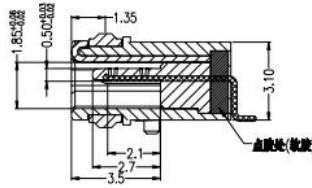
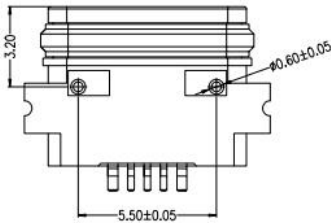

6	GLUE	EPOXY	COLOR BLACK	1
5	RING	SILICON	COLOR GREEN	1
4	OUT SHELL	STAINLESS STEEL 0.25#		1
3	SHELL	STAINLESS STEEL	NICKEL PLATING OVERALL	1
2	CONTACT	COPPER ALLOY 0.2#	GOLD PLATING OVERALL	5
1	HOUSING	HIGH TEMPERATURE PLASTIC	COLOR BLACK	1
NO.	DESCRIPTION	MATERIAL	REMARKS	QTY

**LZG** LZG INDUSTRIAL CO. LTD

PART NAME	WATERPROFF MICRO USB 5P B TYPE	TOLERANCE UNLESS OTHERWISE SPECIFIED:	0.0±0.3 0.00±0.2 0.000±0.1	0.°±2° 0.0°±1° 0.00°±0.5°	UNIT: mm
PART NO.	ZB43006-06SBAP-A				

DRAWING:	林生爵	DATE:	2020.02.18	SCALE	1:1
CHECK:	李念南	DATE:	2020.02.18	MATERIAL	*
APPROVAL:	林生爵	DATE:	2020.02.18	DWG. NO.	
DRAWING NO.	ZB43006-06SBAP-A			SHEET	1/1